





ΣΕΛΙΔΑ 1	ΔΙΑΔΡΟΜΗ: Terradura-Σχινιάς Terradura-Βαρνάβας	ΧΛΜ ΔΙΑΔΡΟΜΗΣ: 75,7 ΜΕΡΙΚΑ ΧΛΜ: 42,53 ΧΡΟΝΟΣ ΒΑΣΗ ΜΩΤ
---------------------------	----------------------------------------------------------	----------------------------------------------------------------------------------

ΣΥΝΟΛΙΚΑ ΧΛΜ		ΚΑΤΕΥΘΥΝΣΗ	ΣΧΟΛΙΑ
ΜΕΡΙΚΑ ΧΛΜ			
1	0,00 0,00		ΠΑΜΕ - ΠΑΜΕ ΠΑΜΕ!
2	0,12 0,12		ΣΕΜΝΑ!
3	0,58 0,46		ΠΡΟΣΟΧΗ! ΕΙΣΟΔΟΣ ΣΕ ΟΔΟ ΜΕΓΑΛΗΣ ΚΥΚΛΟΦΟΡΙΑΣ!
4	0,99 0,41		ΦΥΤΩΡΙΑ ΤΣΑΚΙΡΗΣ
5	2,35 1,36		

ΣΕΛΙΔΑ 2	ΔΙΑΔΡΟΜΗ: Terradura-Σχινιάς Terradura-Βαρνάβας	ΧΛΜ ΔΙΑΔΡΟΜΗΣ: 75,7 ΜΕΡΙΚΑ ΧΛΜ: 42,53 ΧΡΟΝΟΣ ΒΑΣΗ ΜΩΤ
---------------------------	----------------------------------------------------------	----------------------------------------------------------------------------------

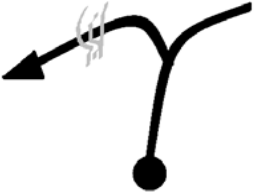
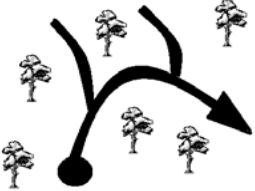
ΣΥΝΟΛΙΚΑ ΧΛΜ		ΚΑΤΕΥΘΥΝΣΗ	ΣΧΟΛΙΑ
	ΜΕΡΙΚΑ ΧΛΜ		
6	2,98 0,63		
7	3,32 0,34		
8	4,81 1,49		
9	5,30 0,49		
10	5,80 0,50		ΠΡΟΣΟΧΗ! ΣΤΟ ΚΑΤΗΦΟΡΙΚΟ ΔΕ ΜΠΟΡΕΙΣ ΝΑ ΦΡΕΝΑΡΕΙΣ! ΦΡΟΝΤΙΣΕ ΝΑ ΕΧΟΥΜΕ "ΑΛΛΑ..."

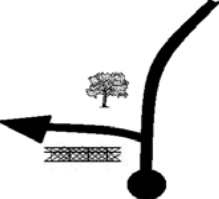
ΣΕΛΙΔΑ 3	ΔΙΑΔΡΟΜΗ: Terradura-Σχινιάς Terradura-Βαρνάβας	ΧΛΜ ΔΙΑΔΡΟΜΗΣ: 75,7 ΜΕΡΙΚΑ ΧΛΜ: 42,53 ΧΡΟΝΟΣ ΒΑΣΗ ΜΩΤ
---------------------------	----------------------------------------------------------	-----------------------------------------------------------------------------------------

	ΣΥΝΟΛΙΚΑ ΧΛΜ	ΚΑΤΕΥΘΥΝΣΗ	ΣΧΟΛΙΑ
	ΜΕΡΙΚΑ ΧΛΜ		
11	6,30 0,50		
12	7,00 0,70		
13	7,32 0,32		
14	7,62 0,30		
15	7,71 0,09		

ΣΕΛΙΔΑ 4	ΔΙΑΔΡΟΜΗ: Terradura-Σχινιάς Terradura-Βαρνάβας	ΧΛΜ ΔΙΑΔΡΟΜΗΣ: 75,7 ΜΕΡΙΚΑ ΧΛΜ: 42,53 ΧΡΟΝΟΣ ΒΑΣΗ ΜΩΤ
---------------------------	----------------------------------------------------------	-----------------------------------------------------------------------------------------

ΣΥΝΟΛΙΚΑ ΧΛΜ	ΚΑΤΕΥΘΥΝΣΗ	ΣΧΟΛΙΑ
ΜΕΡΙΚΑ ΧΛΜ		
7,78		
16 0,07		
7,86		
17 0,08		
8,01		ΚΑΤΗΦΟΡΑ... ΠΑΜΕ ΚΑΤΩ!
18 0,15		
8,33		
19 0,32		
8,64		ΠΡΟΣΟΧΗ! SOS!
20 0,31		

ΣΕΛΙΔΑ 5	ΔΙΑΔΡΟΜΗ: Terradura-Σχινιάς Terradura-Βαρνάβας	ΧΛΜ ΔΙΑΔΡΟΜΗΣ: 75,7 ΜΕΡΙΚΑ ΧΛΜ: 42,53 ΧΡΟΝΟΣ ΒΑΣΗ ΜΩΤ
---------------------------	----------------------------------------------------------	-----------------------------------------------------------------------------------------

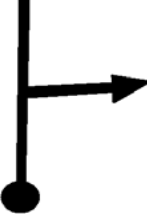
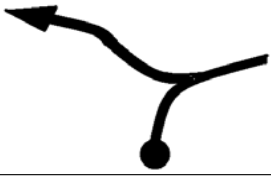
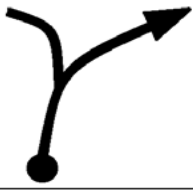
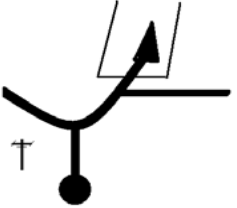
ΣΥΝΟΛΙΚΑ ΧΛΜ	ΚΑΤΕΥΘΥΝΣΗ	ΣΧΟΛΙΑ
ΜΕΡΙΚΑ ΧΛΜ		
9,37		
21 0,73		
10,25		
22 0,88		
10,63		
23 0,38		
11,31		
24 0,68		
11,55		
25 0,24		

ΣΕΛΙΔΑ 6	ΔΙΑΔΡΟΜΗ: Terradura-Σχινιάς Terradura-Βαρνάβας	ΧΛΜ ΔΙΑΔΡΟΜΗΣ: 75,7 ΜΕΡΙΚΑ ΧΛΜ: 42,53 ΧΡΟΝΟΣ ΒΑΣΗ ΜΩΤ
---------------------------	----------------------------------------------------------	-----------------------------------------------------------------------------------------

ΣΥΝΟΛΙΚΑ ΧΛΜ		ΚΑΤΕΥΘΥΝΣΗ	ΣΧΟΛΙΑ
	ΜΕΡΙΚΑ ΧΛΜ		
26	12,89 1,34		
27	13,65 0,76		
28	14,37 0,72		
29	14,76 0,39		ΠΟΛΥ.... ΘΕΑ!
30	17,31 2,55		





ΣΕΛΙΔΑ 7	ΔΙΑΔΡΟΜΗ: Terradura-Σχινιάς Terradura-Βαρνάβας	ΧΛΜ ΔΙΑΔΡΟΜΗΣ: 75,7 ΜΕΡΙΚΑ ΧΛΜ: 42,53 ΧΡΟΝΟΣ ΒΑΣΗ ΜΩΤ
---------------------------	----------------------------------------------------------	----------------------------------------------------------------------------------

ΣΥΝΟΛΙΚΑ ΧΛΜ		ΚΑΤΕΥΘΥΝΣΗ	ΣΧΟΛΙΑ
ΜΕΡΙΚΑ ΧΛΜ			
31	17,80 0,49		
32	19,36 1,56		
33	19,53 0,17		
34	19,84 0,31		ΠΡΟΣΟΧΗ! ΕΡΧΕΤΑΙ ΠΟΛΥ ΓΡΗΓΟΡΑ!
35	20,24 0,40		



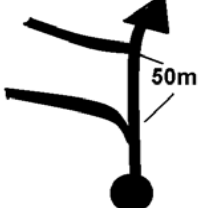

ΣΕΛΙΔΑ 8	ΔΙΑΔΡΟΜΗ: Terradura-Σχινιάς Terradura-Βαρνάβας	ΧΛΜ ΔΙΑΔΡΟΜΗΣ: 75,7 ΜΕΡΙΚΑ ΧΛΜ: 42,53 ΧΡΟΝΟΣ ΒΑΣΗ ΜΩΤ
---------------------------	----------------------------------------------------------	----------------------------------------------------------------------------------

ΣΥΝΟΛΙΚΑ ΧΛΜ ΜΕΡΙΚΑ ΧΛΜ	ΚΑΤΕΥΘΥΝΣΗ	ΣΧΟΛΙΑ
22,47 36 2,23		ΜΕΣΑ! ΣΤΟ ΜΑΓΙΚΟ ΠΟΤΑΜΑΚΙ!
23,52 37 1,05		
24,23 38 0,71		ΠΡΟΣΟΧΗ! Η ΠΟΡΤΑ ΘΑ ΕΙΝΑΙ ΚΛΕΙΣΤΗ! ΠΑΣ ΔΙΠΛΑ ΑΠΟ ΤΗ ΜΠΑΡΙΕΡΑ ΠΡΟΣΕΚΤΙΚΑ ΓΙΑ ΝΑ ΜΗΝ ΣΕ ΨΑΧΝΟΥΜΕ ΣΤΟ ΓΚΡΕΜΟ!
25,53 39 1,30		
27,44 40 1,91		

ΣΕΛΙΔΑ 9	ΔΙΑΔΡΟΜΗ: Terradura-Σχινιάς Terradura-Βαρνάβας	ΧΛΜ ΔΙΑΔΡΟΜΗΣ: 75,7 ΜΕΡΙΚΑ ΧΛΜ: 42,53 ΧΡΟΝΟΣ ΒΑΣΗ ΜΩΤ
---------------------------	----------------------------------------------------------	----------------------------------------------------------------------------------

ΣΥΝΟΛΙΚΑ ΧΛΜ		ΚΑΤΕΥΘΥΝΣΗ	ΣΧΟΛΙΑ
	ΜΕΡΙΚΑ ΧΛΜ		
27,64	0,20		
41			
29,19	1,55		
42			
30,12	0,93		
43			
30,84	0,72		
44			
31,31	0,47		
45			

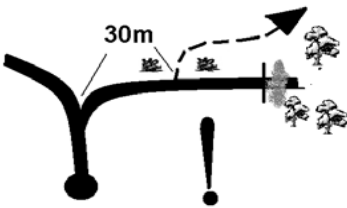

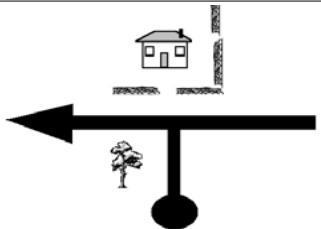
ΣΕΛΙΔΑ 10	ΔΙΑΔΡΟΜΗ: Terradura-Σχινιάς Terradura-Βαρνάβας	ΧΛΜ ΔΙΑΔΡΟΜΗΣ: 75,7 ΜΕΡΙΚΑ ΧΛΜ: 42,53 ΧΡΟΝΟΣ ΒΑΣΗ ΜΩΤ
----------------------------	----------------------------------------------------------	-----------------------------------------------------------------------------------------

ΣΥΝΟΛΙΚΑ ΧΛΜ ΜΕΡΙΚΑ ΧΛΜ	ΚΑΤΕΥΘΥΝΣΗ	ΣΧΟΛΙΑ
32,05 46 0,74		
33,02 47 0,97		
33,25 48 0,23		ΠΑΝΩ ΑΠΟΦΕΥΓΕΙΣ ΤΟ ΑΝΑΧΩΜΑ ΤΗΣ ΟΙΚΟΠΕΔΟΠΟΙΗΣΗΣ
33,33 49 0,08		
34,70 50 1,37		

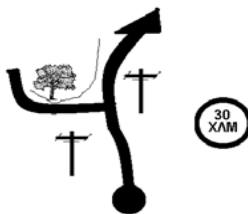
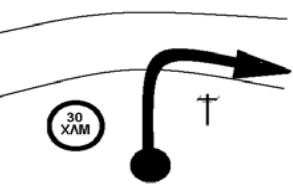
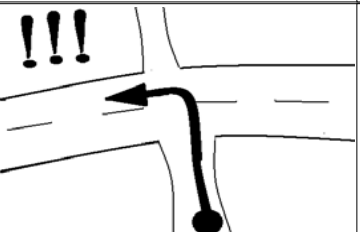
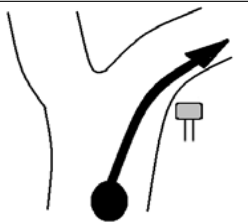
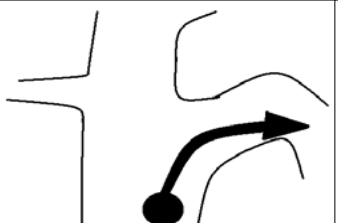
ΣΕΛΙΔΑ 11	ΔΙΑΔΡΟΜΗ: Terradura-Σχινιάς Terradura-Βαρνάβας	ΧΛΜ ΔΙΑΔΡΟΜΗΣ: 75,7 ΜΕΡΙΚΑ ΧΛΜ: 42,53 ΧΡΟΝΟΣ ΒΑΣΗ ΜΩΤ
----------------------------	----------------------------------------------------------	----------------------------------------------------------------------------------

ΣΥΝΟΛΙΚΑ ΧΛΜ	ΚΑΤΕΥΘΥΝΣΗ	ΣΧΟΛΙΑ
ΜΕΡΙΚΑ ΧΛΜ		
35,19		
51 0,49		
35,60		
52 0,41		
36,44		
53 0,84		
37,58		
54 1,14		
38,07		ΓΙΑ ΒΕΝΖΙΝΗ ΠΑΣ ΑΡΙΣΤΕΡΑ ΣΤΟΝ ΚΕΝΤΡΙΚΟ ΣΤΟ ΧΩΡΙΟ ΚΑΙ ΕΠΙΣΤΡΕΦΕΙΣ ΓΙΑ ΣΥΝΕΧΕΙΑ
55 0,49		

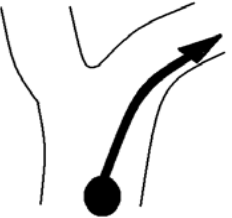
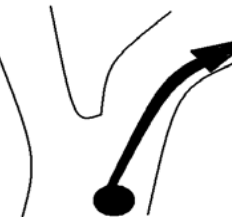
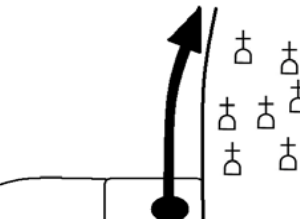

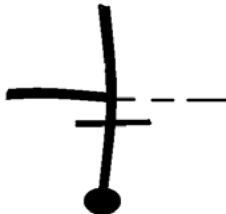
ΣΕΛΙΔΑ 12	ΔΙΑΔΡΟΜΗ: Terradura-Σχινιάς Terradura-Βαρνάβας	ΧΛΜ ΔΙΑΔΡΟΜΗΣ: 75,7 ΜΕΡΙΚΑ ΧΛΜ: 42,53 ΧΡΟΝΟΣ ΒΑΣΗ ΜΩΤ
----------------------------	----------------------------------------------------------	-----------------------------------------------------------------------------------------

ΣΥΝΟΛΙΚΑ ΧΛΜ ΜΕΡΙΚΑ ΧΛΜ	ΚΑΤΕΥΘΥΝΣΗ	ΣΧΟΛΙΑ
38,56 56 0,49		ΠΡΟΣ ΝΕΚΡΟΤΑΦΕΙΟ
40,55 57 1,99		ΠΡΟΣ ΝΕΚΡΟΤΑΦΕΙΟ
41,08 58 0,53		
42,05 59 0,97	ΣΚΟΥΠΙΔΙΑ 	
42,53 60 0,48		ΤΕΛΟΣ ΤΜΗΜΑΤΟΣ



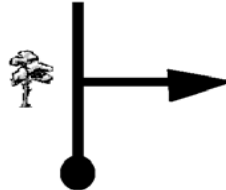
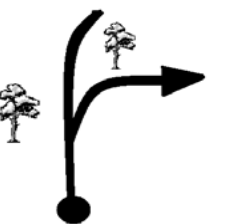
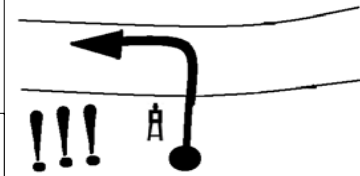

ΣΕΛΙΔΑ 1	ΔΙΑΔΡΟΜΗ: Terradura-Σχινιάς Βαρνάβας-Σχινιάς	ΧΛΜ ΔΙΑΔΡΟΜΗΣ: 75,7 ΜΕΡΙΚΑ ΧΛΜ: 33,17 ΧΡΟΝΟΣ ΒΑΣΗ ΜΩΤ
---------------------------	---------------------------------------------------------------	----------------------------------------------------------------------------------

	ΣΥΝΟΛΙΚΑ ΧΛΜ		ΚΑΤΕΥΘΥΝΣΗ	ΣΧΟΛΙΑ
		ΜΕΡΙΚΑ ΧΛΜ		
1	0,00	0,00		ΜΗΔΕΝΙΣΕ ΣΤΗ ΔΙΑΣΤΑΥΡΩΣΗ... ΑΚΟΛΟΥΘΟΥΝ ΠΕΤΡΑΔΑΚΙΑ!
2	0,69	0,69		
3	0,91	0,22		
4	1,55	0,64		
5	2,11	0,56		

ΣΕΛΙΔΑ 2	ΔΙΑΔΡΟΜΗ: Terradura-Σχινιάς Βαρνάβας-Σχινιάς	ΧΛΜ ΔΙΑΔΡΟΜΗΣ: 75,7 ΜΕΡΙΚΑ ΧΛΜ: 33,17 ΧΡΟΝΟΣ ΒΑΣΗ ΜΩΤ
---------------------------	---------------------------------------------------------------	----------------------------------------------------------------------------------

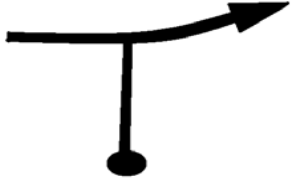
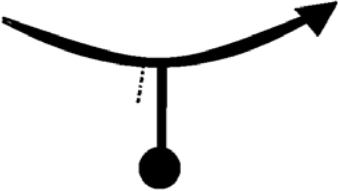
ΣΥΝΟΛΙΚΑ ΧΛΜ	ΚΑΤΕΥΘΥΝΣΗ	ΣΧΟΛΙΑ
ΜΕΡΙΚΑ ΧΛΜ		
2,45		
6 0,34		
2,84		
7 0,39		
4,94		
8 2,10		
7,96		
9 3,02		
8,20		
10 0,24		

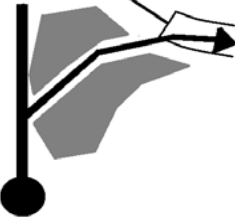
ΣΕΛΙΔΑ 3	ΔΙΑΔΡΟΜΗ: Terradura-Σχινιάς Βαρνάβας-Σχινιάς	ΧΛΜ ΔΙΑΔΡΟΜΗΣ: 75,7 ΜΕΡΙΚΑ ΧΛΜ: 33,17 ΧΡΟΝΟΣ ΒΑΣΗ ΜΩΤ
---------------------------	--------------------------------------------------------	-----------------------------------------------------------------------------------------

ΣΥΝΟΛΙΚΑ ΧΛΜ	ΚΑΤΕΥΘΥΝΣΗ	ΣΧΟΛΙΑ
ΜΕΡΙΚΑ ΧΛΜ		
8,71		
11 0,51		
10,58		
12 1,87		
10,95		
13 0,37		
12,04		
14 1,09		
13,12		
15 1,08		



ΣΕΛΙΔΑ 4	ΔΙΑΔΡΟΜΗ: Terradura-Σχινιάς Βαρνάβας-Σχινιάς	ΧΛΜ ΔΙΑΔΡΟΜΗΣ: 75,7 ΜΕΡΙΚΑ ΧΛΜ: 33,17 ΧΡΟΝΟΣ ΒΑΣΗ ΜΩΤ
---------------------------	--------------------------------------------------------	-----------------------------------------------------------------------------------------

ΣΥΝΟΛΙΚΑ ΧΛΜ	ΚΑΤΕΥΘΥΝΣΗ	ΣΧΟΛΙΑ
ΜΕΡΙΚΑ ΧΛΜ		
14,35		
16 1,23		
15,03		
17 0,68		
15,98		
18 0,95		
16,78		
19 0,80		
16,85		ΚΑΙ ΑΚΟΛΟΥΘΕΙΣ ΤΟ ΠΛΑΚΟΣΤΡΩΤΟ
20 0,07		

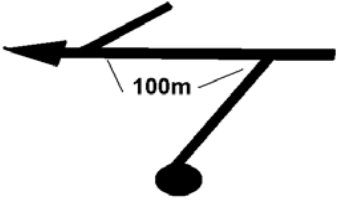

ΣΕΛΙΔΑ 5	ΔΙΑΔΡΟΜΗ: Terradura-Σχινιάς Βαρνάβας-Σχινιάς	ΧΛΜ ΔΙΑΔΡΟΜΗΣ: 75,7 ΜΕΡΙΚΑ ΧΛΜ: 33,17 ΧΡΟΝΟΣ ΒΑΣΗ ΜΩΤ
---------------------------	--------------------------------------------------------	-----------------------------------------------------------------------------------------

ΣΥΝΟΛΙΚΑ ΧΛΜ	ΚΑΤΕΥΘΥΝΣΗ	ΣΧΟΛΙΑ
ΜΕΡΙΚΑ ΧΛΜ		
17,18		
21 0,33		
17,70		
22 0,52		
18,13		
23 0,43		
19,56		ΠΕΤΡΟΔΡΟΜΑΚΙ
24 1,43		
20,01		
25 0,45		

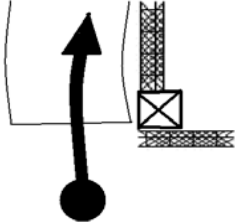
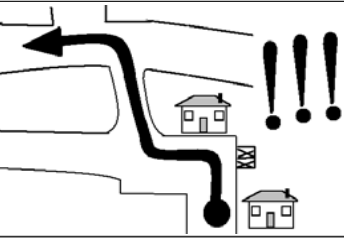
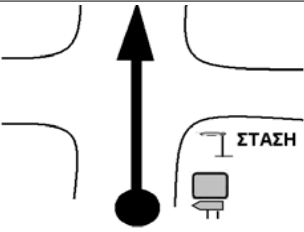
ΣΕΛΙΔΑ 6	ΔΙΑΔΡΟΜΗ: Terradura-Σχινιάς Βαρνάβας-Σχινιάς	ΧΛΜ ΔΙΑΔΡΟΜΗΣ: 75,7 ΜΕΡΙΚΑ ΧΛΜ: 33,17 ΧΡΟΝΟΣ ΒΑΣΗ ΜΩΤ
---------------------------	--------------------------------------------------------	-----------------------------------------------------------------------------------------

ΣΥΝΟΛΙΚΑ ΧΛΜ	ΚΑΤΕΥΘΥΝΣΗ	ΣΧΟΛΙΑ
ΜΕΡΙΚΑ ΧΛΜ		
20,19		
26 0,18		
20,99		
27 0,80		
22,45		
28 1,46		
22,79		
29 0,34		
23,26		
30 0,47		

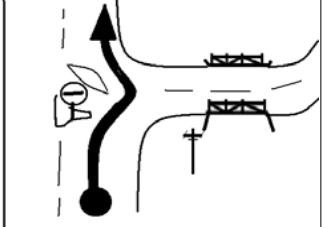
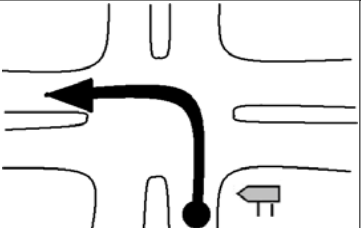
ΣΕΛΙΔΑ 7	ΔΙΑΔΡΟΜΗ: Terradura-Σχινιάς Βαρνάβας-Σχινιάς	ΧΛΜ ΔΙΑΔΡΟΜΗΣ: 75,7 ΜΕΡΙΚΑ ΧΛΜ: 33,17 ΧΡΟΝΟΣ ΒΑΣΗ ΜΩΤ
---------------------------	--------------------------------------------------------	-----------------------------------------------------------------------------------------

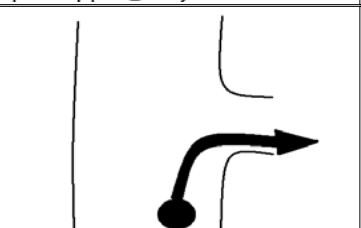
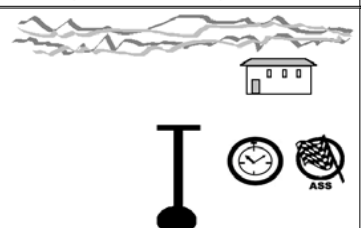
ΣΥΝΟΛΙΚΑ ΧΛΜ ΜΕΡΙΚΑ ΧΛΜ	ΚΑΤΕΥΘΥΝΣΗ	ΣΧΟΛΙΑ
24,35 1,09		
31		
25,13 0,78		
32		
27,90 2,77		
33		
32,64 4,74		ΤΑΒΕΡΝΑ "ΤΟ ΔΕΛΦΙΝΙ"
34		
33,17 0,53		ΕΦΤΑΣΕΣ!
35		